

Before using your stairlift, please read through these instructions carefully.

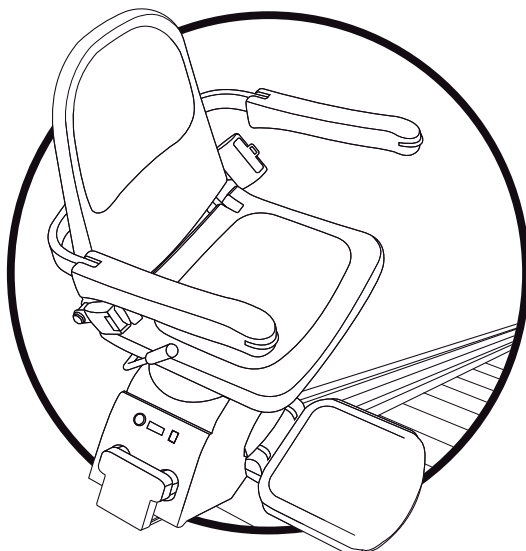

ACORN
STAIRLIFTS

ENGLISH



Thank you for choosing Acorn.

You can rest assured that your stairlift will provide many years of reliable service and allow you to enjoy the full use of your home.

Your stairlift is covered by a manufacturer's warranty for 12 months that covers the cost of replacement parts.

However, problems arising as a result of misuse of the equipment are not covered by the warranty.

Your stairlift is expertly designed and manufactured to the very highest standards. Regular maintenance is required to ensure safe and trouble-free service.

Acorn, in keeping with its policy of continual development, reserves the right to change specification without prior notice. All measurements are approximate. All images are shown for illustrative purposes only. Product may vary slightly.

YOUR STAIRLIFT

ENGLISH

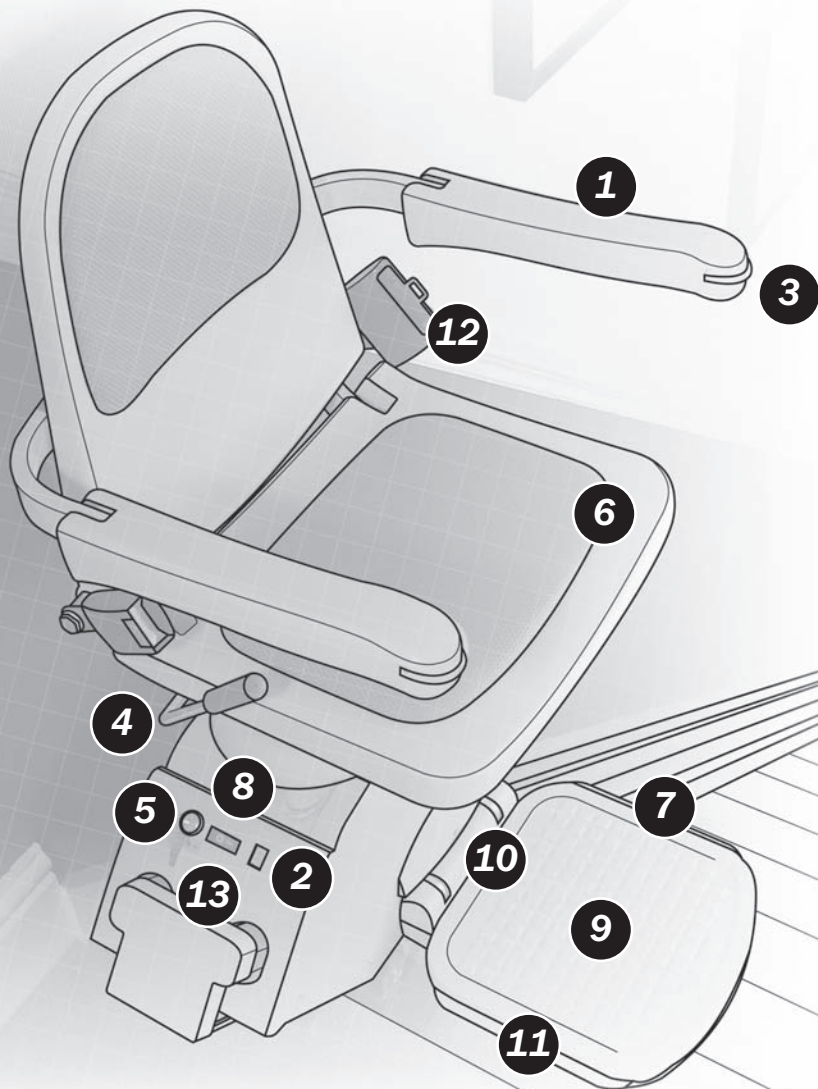

YOUR STAIRLIFT

The Acorn Stairlift is an electrically powered stairlift designed for domestic use. If used correctly, it will provide many years of safe, reliable service.

It is designed to carry one person weighing no more than 127kg (280lbs, 20 stone)

The Acorn Stairlift is powered by an internal battery pack that is charged from the residential mains supply/wall outlet via a transformer that reduces the voltage to a safe level. This means that there is no risk of electric shock and also that the stairlift will continue to function even if the mains electricity supply is interrupted.

- 1 Folding armrest
- 2 Status display panel
- 3 Paddle control
- 4 Seat swivel lever
- 5 Key switch
- 6 Folding seat base
- 7 Safety sensor down
- 8 Battery isolation switch
- 9 Footrest anti-slip surface
- 10 Folding footrest
- 11 Safety sensor up
- 12 Seat belt
- 13 Infra-red sensor

GENERAL NOTES ON SAFETY

ENGLISH

- Ensure that the stairway is not being used by others and is clear of articles or obstructions before using the stairlift.
- Relax and sit well back in the seat with your arms on the armrests and your feet well back on the footrest.
- An inertia type seat belt is fitted, ensure it is fastened securely.



DANGER! The stairlift is designed to carry one person at a time. Never attempt to carry more than one person.

DANGER! Do not allow children to play with the stairlift. Use by children should always be supervised. For safety, it is advisable to switch off the stairlift and remove the key if there is a risk of tampering by children.



Ensure other members of your household or visitors are aware that the stairlift is in use; make them aware of any potential trip hazards.

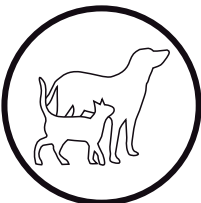

Ensure that household pets are out of harms way before using the stairlift.

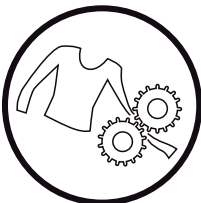

DANGER! Ensure that there are no articles of your clothing that could become trapped in the stairlift mechanism, as this could result in personal injury and/or damage to the equipment. Always check that your clothing is clear of the rail and carriage assemblies before using the stairlift.

CAUTION! It is possible for small items to be dropped onto the stairlift rail and then slide down the rail and into the stairlift mechanism. If you suspect that any foreign object has become trapped in the equipment, consult your Acorn representative before further use.

WARNING! To disconnect the AC power supply from the stairlift system, switch off the power and remove the transformer from the wall socket/outlet. Switch off the battery isolation (*Number 8 on page 5*) from the carriage unit to prevent battery drain.

Do not use the stairlift if you have not been given a demonstration by the installation engineer.

STAIRLIFT OPERATION

KEY SWITCH

You will find the key switch on the carriage cover. For the unit to operate, the key must be inserted and turned to the right (clockwise).

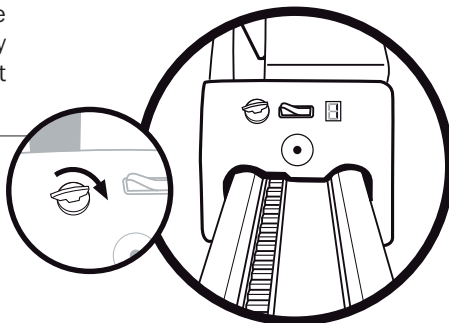

The display panel, positioned near the key switch, will indicate 'A1'. If the display is not indicating 'A1', please check the **DIGITAL DISPLAY CODES** on pages 17-20.



However, when the key is turned to the left or withdrawn, the display panel will show 'E9' and the stairlift will not run.



The key can also be removed to prevent any unauthorized use.

This will not affect the charging.

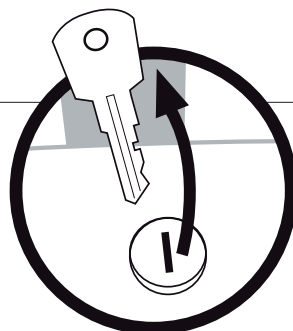

STAIRLIFT OPERATION

PADDLE CONTROL

The paddle control is located on the chair arm. To operate the unit, the paddle must be pressed and held in the direction of travel.

There will be an audible beep to signal that a command has been received.

The unit will only operate while the paddle is being pressed, and will automatically stop when the unit reaches the end of the track or the paddle is released.

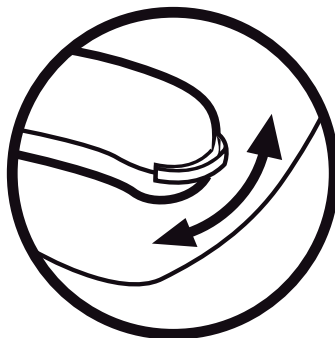

If a beep cannot be heard when the paddle is pressed, check the display code and refer to the digital display codes on pages 17-20.

REMOTE CONTROLS

The unit may also be operated with the remote control handset*. There are two buttons on the handset; RED and GREEN, or UP and DOWN depending on the type of handset you have been supplied.

To send the unit **UP**, press and hold the **RED (OR UP)** button. To send it **DOWN**, press and hold the **GREEN (OR DOWN)** button. The unit will automatically stop at the end of the track or if the button is released.

NOTE: *The paddle control will always override remote controls.*



*Remote handset may vary from that shown

STAIRLIFT OPERATION

The unit will operate with the seat arms, seat pad or footrest in the folded position. However, it will not work if the seat has been turned (*or the safety arm has been left up*). This will be indicated by 'E5' on the display panel.



Occasional interference from outside sources may, in some instances, cause the lift to stop. This is a normal feature, designed to prevent accidental operation. The remote control will require the button to be released and pressed again.

IT IS RECOMMENDED THAT THE BATTERY IN THE REMOTE CONTROL HANDSET IS REPLACED EVERY 6 MONTHS

SWIVEL SEAT

When the unit reaches the upper end of the track, it will stop automatically. The seat may now be turned to make getting on and off the stairlift easier.

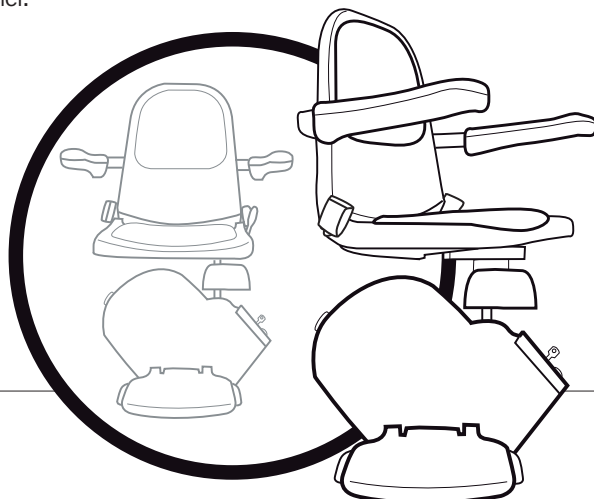

STAIRLIFT OPERATION

ENGLISH

To turn the seat, depress and hold down the locking lever at the side of the seat pad. This will then allow the seat to be rotated to face the staircase landing. The seat will lock at 45° and 90° from the travel position.

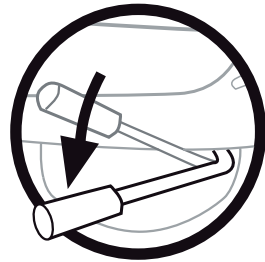

Make sure the seat is locked into position before getting on or off the stairlift.

The unit will not operate further until the seat has been rotated back to the travel position. Failure to do so will indicate 'E5' on the display panel.



Safety Note: The footrest does not swivel, and the seat only swivels at the top of the staircase.

SEAT BELT

To fasten the seat belt, pull out the belt and insert the clasp into the buckle. A positive click should be heard, indicating that the lock has engaged properly.

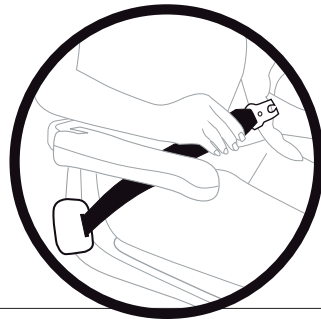

To release the seat belt, hold the belt with one hand and press the release button on the buckle. The clasp will automatically release and allow the belt to retract.



It is important that the belt is held while it retracts, otherwise it will retract too fast, resulting in the belt 'whipping' which may cause injury.

STAIRLIFT OPERATION

FOLDING SEAT/FOOTREST

The seat, arms and footrest can be folded up when not in use to allow greater access on the stairway, efficiently using the space in your hallway.

The lift can still be operated using the remote control handset.

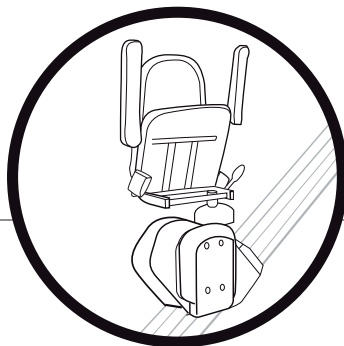

PARKING AND RECHARGING

When not in use, it is vital that the unit is left at the correct position on the track. This will depend upon which type of track is fitted.

On a standard track, the correct positions are at the top or bottom where the unit stops automatically. At these positions, the unit receives a power supply from the mains/transformer that allows the unit to recharge its internal batteries.

The lift will make a single 'beep' to indicate that a charge point has been reached.

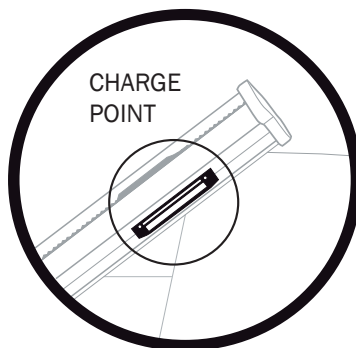

The mains electricity supply/transformer should be left permanently connected and switched on.

STAIRLIFT OPERATION

DISCONNECTING THE POWER



The following procedure must be followed to avoid battery failure, which is not covered by the manufacturer's warranty.

If the unit is not to be used for a considerable amount of time; e.g. holidays/vacations etc., you may prefer to disconnect the unit from the mains supply.

Switch off the mains supply. Remove the transformer from the wall outlet.

(The unit will now make a constant 'beep'; this is the no-charge warning.)

Switch off the battery isolation on the carriage. (Located next to the key and display panel on the carriage unit.)

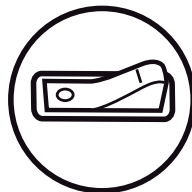
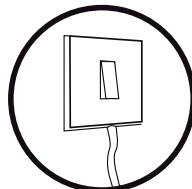

DO NOT DISCONNECT THE UNIT DURING NORMAL DAILY USE. THIS WILL PREVENT THE STAIRLIFT BATTERIES FROM CHARGING.

LIFT WILL NOT RUN

In the unlikely event that a problem should occur, take a note of the fault code displayed and contact your authorized dealer for assistance.

DEALER STAMP

SAFETY FEATURES

The stairlift comes with an array of safety features as standard; including:

- **Carriage safety pads; upper and lower**
Stops unit on contact with obstruction on track
- **Footrest safety edges; upper and lower**
Stops unit on contact with obstruction on stairway
- **Swivel seat switch**
Prevents accidental movement of the stairlift with the seat swivelled
- **Final limit switch**
Prevents over-travel
- **Over speed governor and safety gear**
Prevents uncontrolled descent
- **No-charge warning**
Audible warning sound

If one or more of the safety devices are activated, an appropriate code will be indicated on the display panel. These codes can be found in the **DIGITAL DISPLAY CODES** on pages 17-20, together with the appropriate action required.

OVER SPEED GOVERNOR

The lift is fitted with a safety device (OSG) that will lock the lift to the rail in the event of a mechanical failure or excessive speed. If the OSG operates spuriously due to excessive shock or vibration, indicated by 'F7' on the display panel, it is possible to hand wind the lift to reset it.



SAFETY FEATURES

HAND WINDING



*To hand wind the lift, the following must be observed.
**WARNING! WHEN HAND WINDING,
ALWAYS OBSERVE FOR POSSIBLE OBSTRUCTIONS***

Turn off the battery isolation switch.

Remove the blanking grommet and insert the winding handle onto the motor spindle.

Turn the winding wheel in a clockwise direction so the lift moves up the track approximately one inch.

Remove the winding wheel and turn on the battery isolation switch.

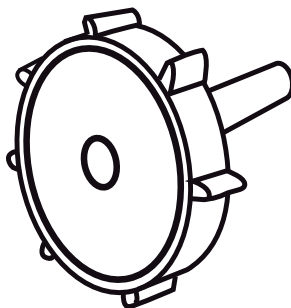

Check the digital display panel has changed from 'F7' to 'A1'. If it still displays 'F7' repeat the above steps.



Run the lift up until it stops automatically, and then down to check all operations are running as they should. Replace the blanking grommet.



CAUTION! Never run the lift with the winding wheel in place as it could result in serious injury or damage. Never wind the lift counter-clockwise/anti-clockwise if the fault code 'F7' shows, as this will result in damage to the OSG.

**IF IN DOUBT, CONTACT YOUR AUTHORIZED
ACORN REPRESENTATIVE FOR FURTHER ADVICE**

CARE AND MAINTENANCE

REMOTE CONTROLS

As previously described, there may be occasions when the remote control handsets* will lose programming due to outside interference. If this happens, you can reset the remote control by sending the carriage to the bottom of the track. Then turn the seat so that the digital display is showing 'E5'.

Press the paddle on the chair arm in the DOWN direction (*even though the stairlift will not move any further*) and, at the same time, press the **RED (OR UP)** button on the remote control for approximately 5 SECONDS.

When the seat is turned back into the correct position, the remote control handset will be correctly programmed.

The infrared remote controls work by using an invisible light source. This naturally occurring light source can also be emitted by certain types of low energy bulbs. If it is found that such a bulb is causing interference with the remote controls, it is recommended that it be changed to a standard one.



*Remote handset may vary from that shown

RAILS

It is recommended that the rail should be cleaned on a weekly basis. This should be done with a dry cloth, and you can use simple household polish. ***Under no circumstances should you use a damp cloth or abrasive cleaner.*** Failure to clean the track on a regular basis will lead to a build up of dust on the internal rollers of the lift, which will in turn leave black marks; and in some instances will leave a residue which can look similar to metal shavings.

It is also recommended that the steel-toothed rack, mounted on the rail itself, should be vacuumed out on a regular basis.

CARE AND MAINTENANCE

SAFETY EDGES

Should the stairlift become unoperational (displaying 'E1', 'E2', 'E3' or 'E4') this could be due to one of the safety edges being trapped. This can be overcome by simply tapping the relevant safety edge gently. If this doesn't rectify the problem, contact your authorized Acorn representative for further assistance.

SLEEP MODE

If the stairlift is not parked on a charge point, the stairlift will 'beep' continuously for approximately 30 seconds, after which the stairlift will enter SLEEP MODE.

The user can 'wake' the stairlift at any time by using the directional or remote control handset. Once woken, park the stairlift on a charge point as normal.

RESET

On certain occasions, it may be necessary to reset the control board of the stairlift. Switch the power off, leave for 30 seconds, then switch back on. This will reset the fault codes in the display panel.

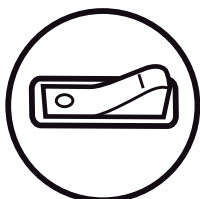

30 seconds

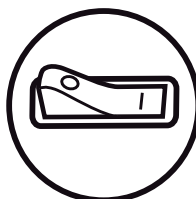

DIGITAL DISPLAY CODES

CHARGING CODES LIFT WILL OPERATE AS NORMAL

1

NORMAL - Battery is charging

Charger connected and operating properly

- Lift is operating normally

NORMAL - Battery is fully charged

Charger connected but not charging - battery is at maximum charge capacity

- Lift is operating normally

FAULT - Battery fault

Charger connected but not charging - battery is not found, or is faulty

- Contact your authorized Acorn dealer for assistance

STANDARD OPERATING CODES LIFT WILL OPERATE AS NORMAL

2

NORMAL - Power down / Sleep mode

No display shown. Lift is either receiving no power; or is in sleep mode.

- Check that the power switch is in the ON position
- Activate the directional paddle to wake the stairlift from 'SLEEP' mode

NORMAL - No charge

LIFT WILL BEEP

Lift has been parked off a charge point, and is receiving no charge.

- Activate the directional paddle and drive the stairlift to a charge point
- Check that the mains supply has not been turned off

NORMAL - Lift moving up

Lift is in operation, and moving upward. Armrest toggle has been activated.

- Lift is operating normally

NORMAL - Lift moving down

Lift is in operation, and moving downward. Armrest toggle has been activated.

- Lift is operating normally

DIGITAL DISPLAY CODES

2

STANDARD OPERATING CODES

LIFT WILL OPERATE AS NORMAL

NORMAL - Lift moving up (remote)
Lift is in operation, and moving upward.
Remote control has been activated.

- Lift is operating normally

NORMAL - Lift moving down (remote)
Lift is in operation, and moving downward.
Remote control has been activated.

- Lift is operating normally

3

OPERATING ERROR CODES

LIFT WILL **NOT** OPERATE

NORMAL - Safety edge activated
Footrest UP safety edge has been activated

- Check the footrest UP safety edge for obstruction

NORMAL - Safety edge activated
Footrest DOWN safety edge has been activated

- Check the footrest DOWN safety edge for obstruction

NORMAL - Safety edge activated
Carriage UP safety edge has been activated

- Check the carriage UP safety edge for obstruction

NORMAL - Safety edge activated
Carriage DOWN safety edge has been activated

- Check the carriage DOWN safety edge for obstruction

NORMAL - Seat not in place
The stairlift seat is not in the riding position

- Turn the seat back to the riding position

NORMAL - Battery low
Battery requires charging

- Activate the directional toggle switch and drive the stairlift to a charge point

NORMAL - Key switch off
Key switch is in the OFF position

- Check that the key is in and turned to the ON position

DIGITAL DISPLAY CODES



NOTE: IF MORE THAN ONE OF THE PREVIOUS OPERATING 'ERRORS' ARE OPERATING TOGETHER (e.g. the seat is not in place, AND the key switch is in the off position) THEN ONE OF THE FOLLOWING HARDWARE FAULT CODES MAY BE DISPLAYED

HARDWARE FAULT CODES

LIFT WILL **NOT** OPERATE

4

H1

NORMAL - Multiple operating error

More than one error has occurred

- Check that more than one of the faults in section 3 are not present, rectify if possible

H2

NORMAL - Multiple operating error

More than one error has occurred

- Refer to section 3 if a different code is displayed after checking and rectifying

H3

NORMAL - Multiple operating error

More than one error has occurred

- If not resolved, please contact your authorized Acorn dealer for assistance

H4

FAULT - Safety device fault

More than one error has occurred, resulting in a safety device fault

- Contact your authorized Acorn dealer for assistance

FATAL ERROR CODES

LIFT WILL **NOT** OPERATE

5

F1

FAULT - Relay fault







- Reset the stairlift (power off for 30 seconds)
- If not resolved, contact your authorized Acorn dealer for assistance

FATAL ERROR CODES continued on next page

DIGITAL DISPLAY CODES

5

FATAL ERROR CODES LIFT WILL **NOT** OPERATE

	FAULT - Brake fault	<ul style="list-style-type: none">• Reset the stairlift (power off for 30 seconds)• Drive the stairlift to a charge point, and leave to charge for one hour• If not resolved, contact your authorized Acorn dealer for assistance
	FAULT - Motor fault	<ul style="list-style-type: none">• Reset the stairlift (power off for 30 seconds)• If not resolved, contact your authorized Acorn dealer for assistance
	FAULT - Motor over-current	<ul style="list-style-type: none">• Reset the stairlift (power off for 30 seconds)• If not resolved, contact your authorized Acorn dealer for assistance
	FAULT - Battery fault	<ul style="list-style-type: none">• Drive the stairlift DOWN to a charge point, and leave to charge
	FAULT - Final limit overrun	<ul style="list-style-type: none">• Hand wind the stairlift up OR down (see <i>hand-winding</i>)• If not resolved, contact your authorized Acorn dealer for assistance
	FAULT - OSG switch	<ul style="list-style-type: none">• Hand wind the lift UP to reset the OSG (see <i>hand-winding</i>)
	FAULT - System lock-out	<ul style="list-style-type: none">• Reset the stairlift (power off for 30 seconds)• If not resolved, contact your authorized Acorn dealer for assistance

LABELS

SUPERGLIDE 120
Acorn Stairlifts BD18 2AX

SERIAL NUMBER

YEAR OF MANUFACTURE CE

OFF ON

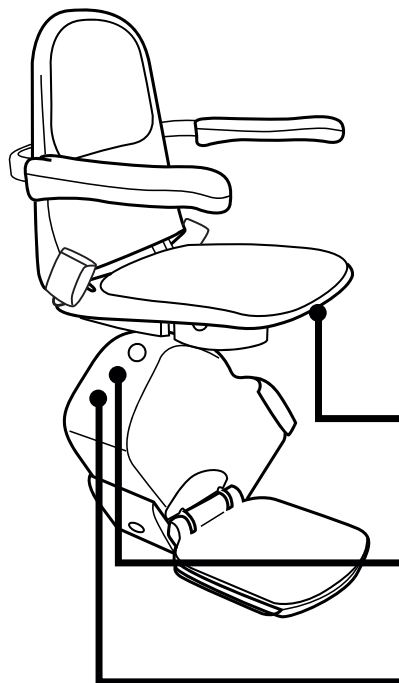
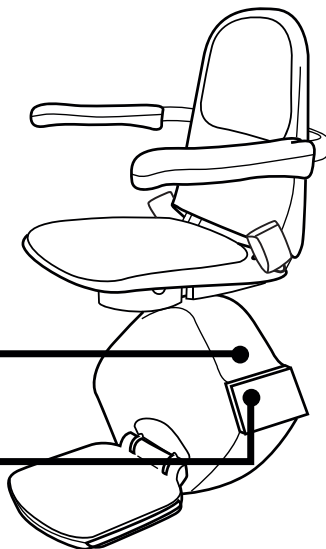

HAND WINDING WHEEL
DO NOT USE UNLESS DIRECTED BY SERVICE ENGINEER!

INSTRUCTIONS

1. Turn off battery isolation switch
2. Remove cover from access hole
3. Insert this hand winding wheel
4. Wind in desired direction keeping Stairlift under constant surveillance
5. Turn on battery isolation switch and replace cover

WARNING! The lift will not work if wound beyond its normal stopping position.

Address Label (under seat)

Manufactured By Acorn Stairlifts
Telecom House
Millennium Business Park
Station Road, Steeton
England BD20 6RB

DOWN HAND WINDING
 UP See instructions on wheel

WARNING
The safe working load is **one** person only at a maximum weight of **127 kgs**

WIRING DIAGRAMS

LOW VOLTAGE WIRING CONTROL BOARD T502

ENGLISH

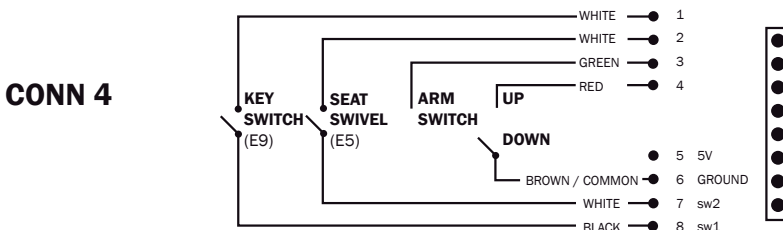
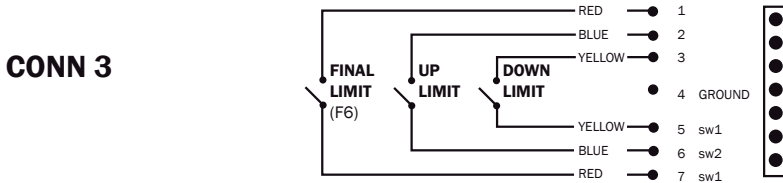
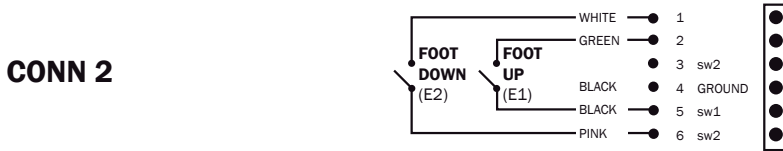
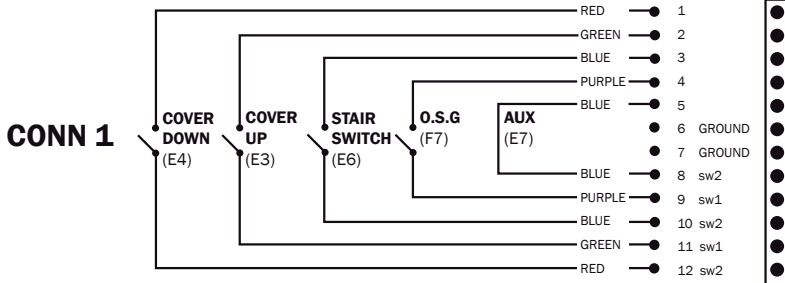

WIRING DIAGRAMS

LOW VOLTAGE WIRING CONTROL BOARD T502

ENGLISH

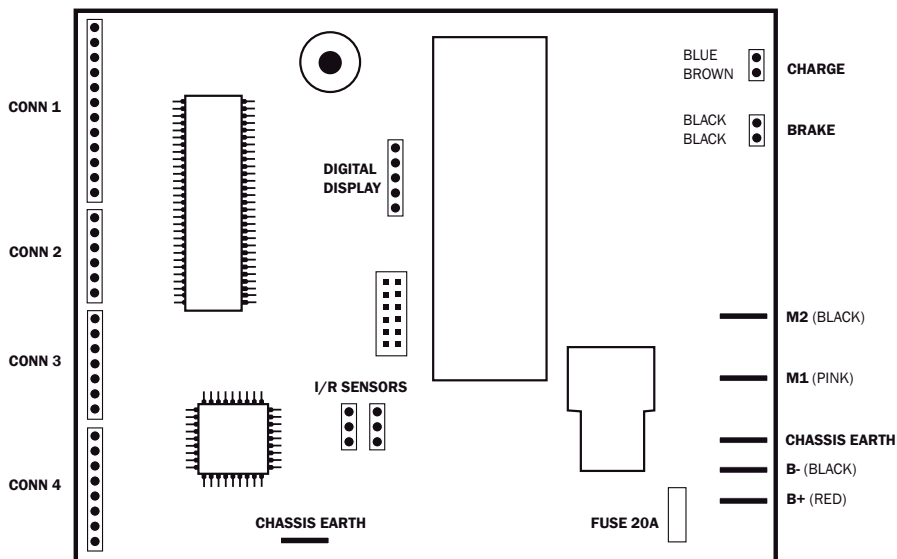

EC Declaration of Conformity

Acorn Mobility Services Ltd.
Spring Mills
Norwood Avenue
ShIPLEY
England
BD18 2AX

Manufacturer: Lothian Electric Machines Ltd
Hospital Road
Haddington
East Lothian
Scotland
EH41 3PD

T: +44 (0) 1535 290 000
F: +44 (0) 1535 290 006
www.acornstairlifts.com

T: +44 (0) 1620 828 700
F: +44 (0) 1620 828 730
www.lemac.com

Product: Stairlift
Model: 120 MKII Superglide - Acorn

The undersigned hereby declares, on behalf of Acorn Mobility Services Ltd, that the above referenced product to which this declaration relates, is in conformity with the essential requirements of:

Machinery Directive 98/37/EC; Electromagnetic Compatibility Directive 89/336/EC, as amended by 91/263/EEC, 92/31/EEC and 93/68/EEC; Low Voltage Directive 73/23/EC

And in accordance with the following standards:

EMC: EN 12015: 1998; EN 12016:1998; EN 55014: 1993
Machinery Directive: EN ISO 12100-1:2003; EN ISO 12100-2:2003;
EN 294:1992; EN 60204-1:2006; EN 954-1:1996;
EN 953:1997

LVD: EN 61558-2-6:1997; EN 61558-1:1997+A1: 1998;
EN 60204-1:2006

Other Standards: ISO9386-2:2000; CAN/CSA B613:2002;
CAN/CSA B355:2003; CSA/B44-1-04/ASME A17.5:2005;
ASME A 18.1:2005; GOST-R; RWTUV; ISTA

The Technical Construction File, as required by Directive 98/37/EC, is maintained at the corporate headquarters of Acorn Mobility Services Ltd, Telecom House, Millennium Business Park, Station Road, Steeton, England, BD20 6RB.

Authorised Signature:



Date: **May 2007**

William Waddell
GROUP QUALITY MANAGER
Acorn Mobility Services Ltd.



ACORN

STAIRLIFTS

ENGLISH

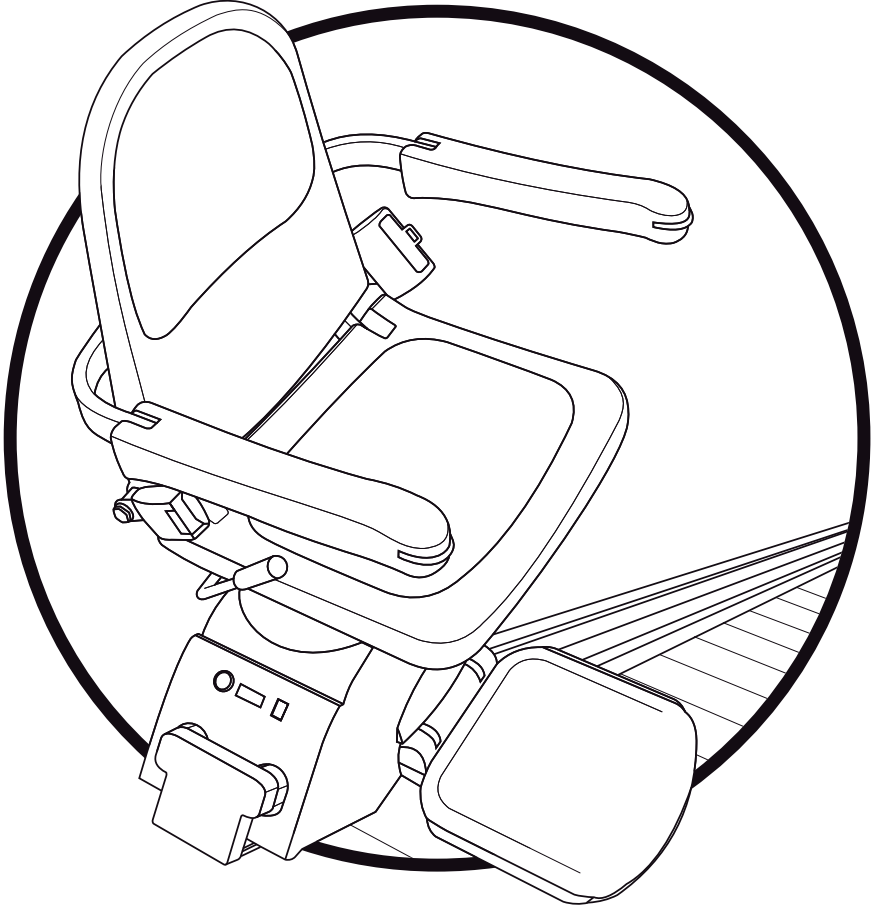

Acorn promotes responsible recycling.
Do not attempt to dispose of the stairlift yourself



Notes:
